

ROCKINGER

RO★100 VARIOBLOC



VARIOBLOC Click & Drive



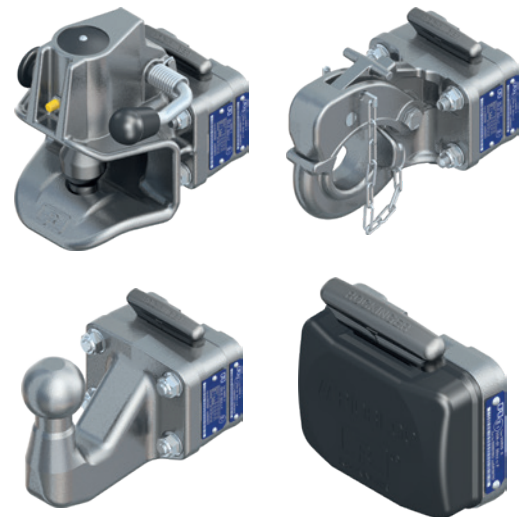



- Multifunktionales Wechselsystem für Transporter, Geländewagen oder Busse in Verbindung mit Bolzen-, Hakenkupplung und Kupplungskugel
- Einfaches Wechseln von vorne auch bei beschränkten Platzverhältnissen durch besonders zugängliche Konstruktion
- Erlaubt das schnelle und einfache Abnehmen oder Wechseln unterschiedlicher Kupplungssysteme
- Besonders geeignet auch für Hecktragesysteme und Arbeitsgeräte
- ECE R55-01 geprüft und zugelassen

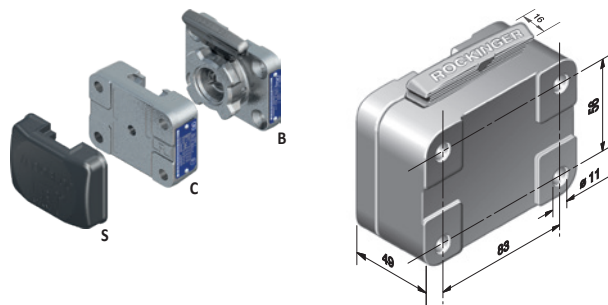

RO★100 VARIOBLOC

Technische Daten





	 (mm)	 D (kN)	 Dc (kN)	 S (kg)	 V (kN)	 (kg)	ECE
ROE 100A01002*	83 x 56	30	30	250	12,0	2,7	E1 55R-01 0044
ROE 100A02002*	85 x 45	30	18	200	9,6	2,7	E1 55R-01 0044

* nur in Verbindung mit RO★243

In der Tabelle finden Sie die maximalen Belastungsdaten. Beachten Sie die tatsächlichen Belastungswerte Ihrer verwendeten Verbindungseinrichtung. Weitere technische Daten finden Sie im Katalog.

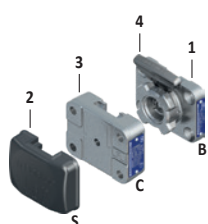
Komponenten



Pos		ROE
01	83,0 x 56,0 mm	ROE 100B01002
01	85,0 x 45,0 mm	ROE 100B02002
02		ROE 25666
03	83,0 x 56,0 mm	ROE 100C01001
03	85,0 x 45,0 mm	ROE 100C02001
04		ROE 70761





Befestigungsätze





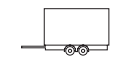

Pos	L	ROE
05	40 mm	ROE 70759
05	50 mm, 30 mm	ROE 70756
05	55 mm	ROE 70570
05	60 mm	ROE 70558
05	110 mm	ROE 70754
05	130 mm, 40 mm	ROE 70805

Kupplung inklusive Wechselplatte







						ECE	
Lastfall A, B	(mm)	D (kN)	Dc (kN)	S (kg)	V (kN)	(kg)	
ROE 100C01511	83 x 56	30	18	250	12,0	4,1	E1 55R-01 0031
	83 x 56	30	30	250	8,4	4,1	



						ECE		
Lastfall C	(mm)	D (kN)	Dc (kN)	S (kg)	V (kN)	C (t)	(kg)	
ROE 100C01521	83 x 56	20	18	150	–	3,5	3,3	E1 55R-01 1958



					ECE		
Lastfall I, II	(mm)	D (kN)	S (kg)	H (mm)	L (mm)	(kg)	
ROE 100C01531*	83 x 56	22,5	275	–34	118	3,9	E1 55R-01 0101
ROE 100C01541*	83 x 56	27,5	300	19	104	3,9	E1 55R-01 0100
ROE 100C01551*	83 x 56	22,1	270	–89	117	4,2	E1 55R-01 0099
ROE 100C01561	83 x 56	19,0	200	–29	136	4,1	E1 55R-01 0101

* Bei Kombination von Basis- und Wechselplatten unterschiedlicher Lochbildausführungen sind die jeweils kleineren Belastungswerte der Tabelle/ISO-Linien zulässig.