

# RO\*100, VARIOBLOC

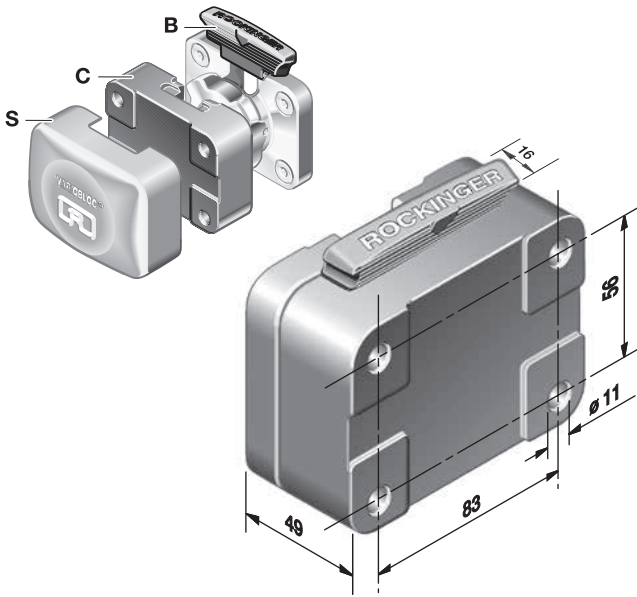





- DE** Multifunktionales Wechselsystem für Transporter, Geländewagen, Busse in Verbindung mit Bolzen-, Hakenkupplung, Kupplungskugel; geeignet für Hecktragesysteme und Arbeitsgeräte.
- EN** Multifunctional alternating system for transporter, cross-country vehicles and buses, in connection with pin hitch, hook trailer hitch, hitch ball, suitable for towbar bracket systems and work devices.
- FR** Système mobile multifonction pour véhicules utilitaires, voitures tout terrain et bus liaison avec accouplement à boulon, à crochet ou boule d'attelage ; convient pour systèmes de portage arrière et outillage.
- IT** Sistema intercambiabile multifunzione per furgoni, fuoristrada, bus in abbinamento a ganci a perno a uncino e ganci a sfera; adatto per sistemi di trasporto posteriori e attrezzi di lavoro.
- ES** Sistema de cambio multifuncional para furgonetas, vehículos todo terreno, autobuses en combinación con enganches de bulón, enganches de gancho, enganches de bola; indicado para sistemas de soporte posterior y útiles de trabajo.

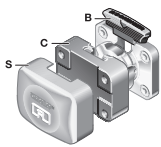





## Technische Daten • Technical data • Données technique • Dati tecnici • Datos técnicos



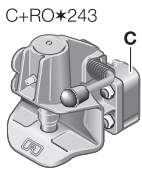



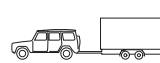
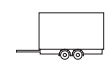

	 (mm)	 D (kN)	 Dc (kN)	 S (kg)   V (kN)	 (kg)	<b>ECE</b>
ROE 100A01001*	83 x 56	30	30	250   12,0	2,7	010044
ROE 100A02001*	85 x 45	30	18	200   9,6	2,7	010044

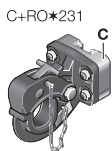
**DE** \* nur in Verbindung mit RO\*243    **EN** \* only in combination with RO\*243    **FR** \* uniquement en combinaison avec RO\*243\*  
**IT** \* solo assieme a ganci a RO\*243    **ES** \* solamente en combinación con RO\*243





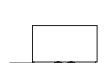

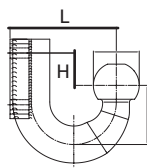
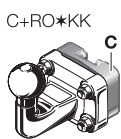

	 (mm)	 D (kN)	 Dc (kN)	 S (kg)   V (kN)	 (kg)	<b>ECE</b>
<b>Lastfall A, B</b> Loading condition A, B	83 x 56	30	18	250   12,0	4,1	010031
	83 x 56	30	30	250   8,4	4,1	



	 (mm)	 D (kN)	 Dc (kN)	 S (kg)   V (kN)	 C (t)	 (kg)	<b>ECE</b>
<b>Lastfall C</b> Loading condition C	83 x 56	20	18	150   -	3,5	3,3	011958



	 (mm)	 D (kN)	 S (kg)	 H (mm)	 L (mm)	 (kg)	<b>ECE</b>
<b>Lastfall I, II</b> Loading condition I, II	83 x 56	22,5	275	-34	118	3,9	010101
ROE 100C01531*	83 x 56	27,5	300	19	104	3,9	010100
ROE 100C01551*	83 x 56	22,1	270	-89	117	4,2	010099
ROE 100C01561	83 x 56	19,0	200	-29	136	4,1	010101

\* Bei Kombination von Basis- und Wechselplatten unterschiedlicher Lochbildausführungen sind die jeweils kleineren Belastungswerte der Tabelle/ISO-Linien zulässig.  
 \* Where base and interchangeable plates with different hole patterns are combined, the lower load figures in the table/ISO-Linien shall be applicable in each case.

# RO\*100

Ersatzteile • Spare parts • Pièces de rechange • Ricambi • Piezas de recambio

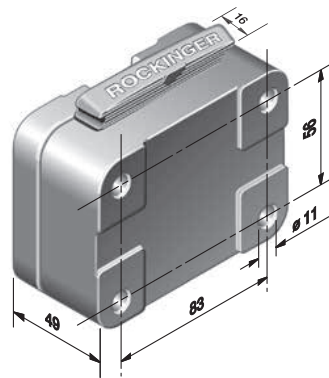
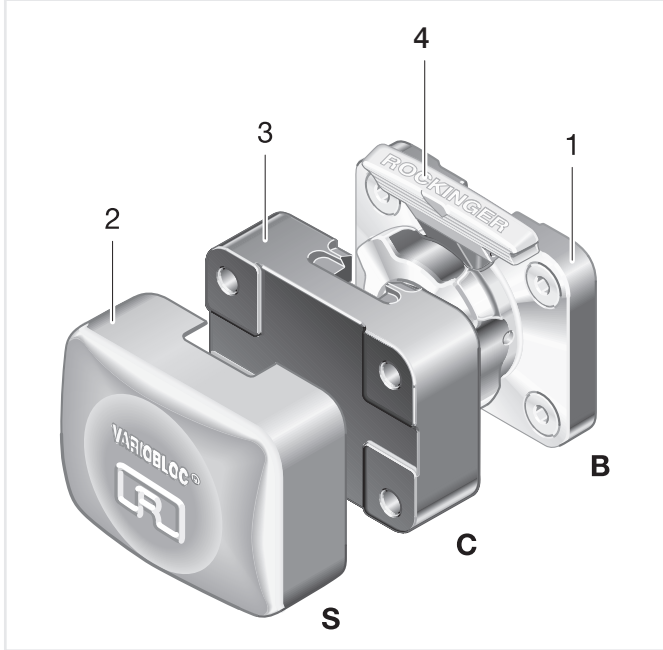

Pos		ROE	
01	83,0 x 56,0 mm	ROE 100B01001	1
01	85,0 x 45,0 mm	ROE 100B02001	1
02		ROE 25344	1
03	83,0 x 56,0 mm	ROE 100C01001	1
03	85,0 x 45,0 mm	ROE 100C02001	1
04		ROE 70761	1

Befestigungssätze • Screw sets • Kits de fixation • Kit di fissaggio • Juego de elementos de sujeción

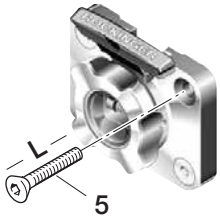

Pos	L	ROE	
05	40 mm	ROE 70759	1
05	50 mm, 30 mm	ROE 70756	1
05	55 mm	ROE 70570	1
05	60 mm	ROE 70558	1
05	110 mm	ROE 70754	1
05	130 mm, 40 mm	ROE 70805	1

Basisplatte • Base plate on the vehicle • Plaque de base • Piastra base • Placa base

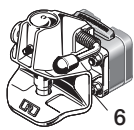

Pos	L	ROE	
06	50 mm	ROE 70755	1

Bolzenkupplung 243 auf Wechselplatte • Pin hitch 243 on the quick-change plate • Accouplement à boulon 243 sur plaque mobile • Gancio a perno 243 su piastra intercambiabile • Enganche de bulón 243 en placa intermedia

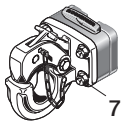

Pos	L	ROE	
07	50 mm	ROE 70755	1

Hakenkupplung 231 auf Wechselplatte • Hook trailer hitch 231 on the quick-change plate • Accouplement à crochet 231 sur plaque mobile • Gancio a uncino 243 su piastra intercambiabile • Enganche de gancho 243 en placa intermedia

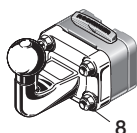

Pos	L	ROE	
08	50 mm	ROE 70755	1
08	60 mm	ROE 70757	1
08	65 mm	ROE 70758	1

Kupplungskugel auf Wechselplatte • Hitch ball on the quick-change plate • Boule d'attelage sur plaque mobile • Gancio a sfera su piastra intercambiabile • Enganche de bola en placa intermedia

# RO\*100, VARIOBLOC

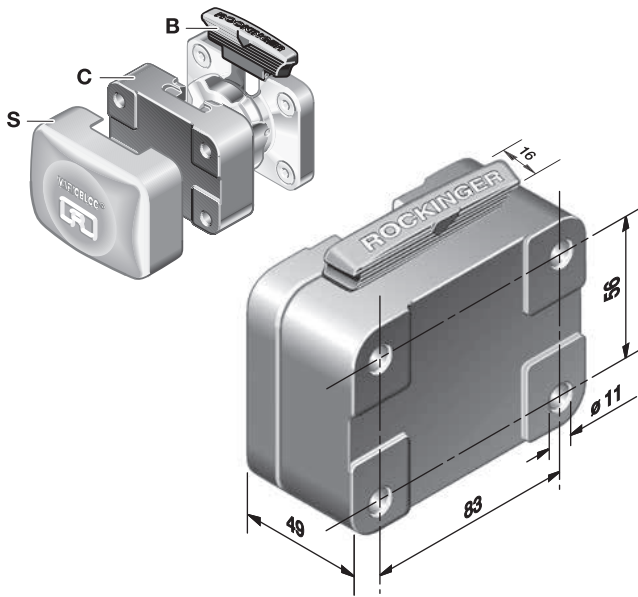

- DE** In Verbindung mit Kugelkupplungen von Fremdherstellern
- EN** In combination with ball hitches from other manufacturers
- FR** Pour les crochets à boule d'autres fabricants
- IT** Assieme a ganci a sfera di altre case produttrici
- ES** En combinación con enganches esféricos de fabricantes ajenos



## ISO 85 x 45 / Y-V / Y-U / X-V

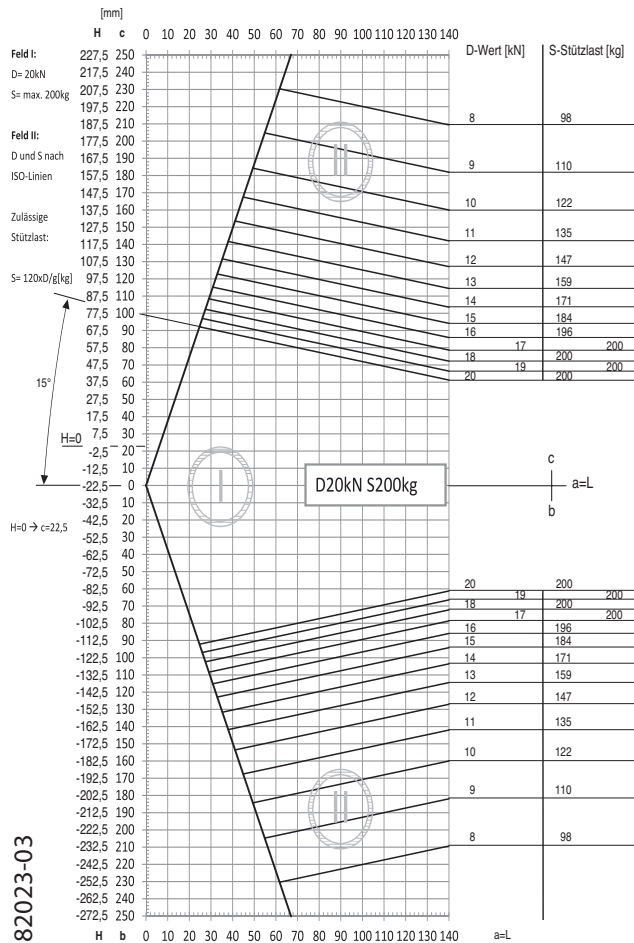

## ISO 83 x 56 / X-U

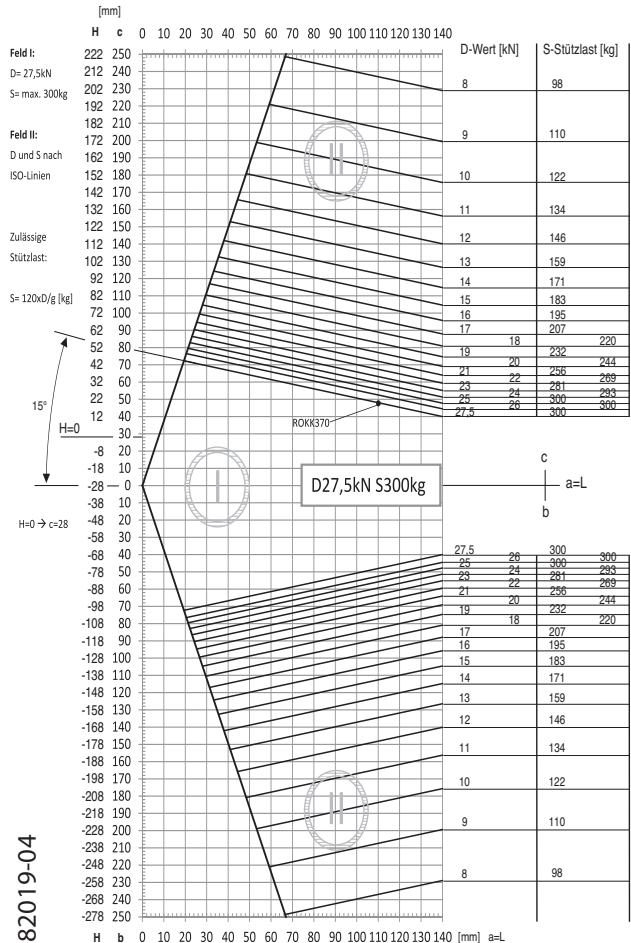

82023-03

82019-04

MUB 016023 M 50 (REV 01) 07-2016 (P-C)

