

RO★244-2

- DE** Kompaktkupplung für Flurförderzeuge und deren Anhänger
- EN** Compact hitch for industrial trucks and trailers
- FR** Crochet d'attelage compact pour chariots de manutention et leurs remorques
- IT** Gancio compatto per adibiti a movimentazione interna con relativi rimorchi
- ES** Enganche compacto para vehículos industriales y sus remolques

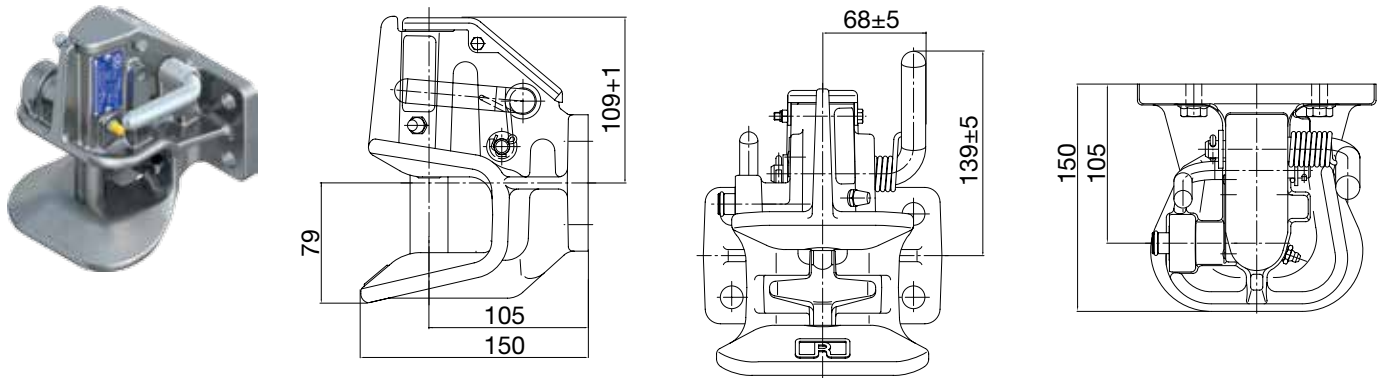

Für Zugöse, for drawbar eye, pour anneaux, per occhioni, para puntas:

1) DIN 74054*

2) DIN 8454

3) CUNA 438/40*

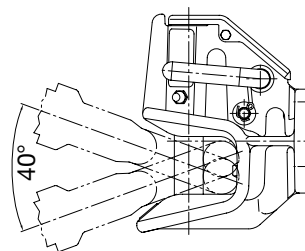
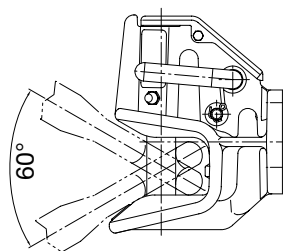
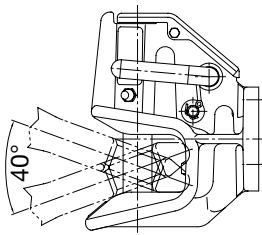

* nur auf nicht-öffentlichen Straßen • only on non-public roads • uniquement sur les routes non publiques • solo su strade non pubbliche • solo en vías no públicas

Technische Daten • Technical data • Données technique • Dati tecnici • Datos técnicos

									ECE
	A		(mm)	D (kN)	Dc (kN)	S (kg)	V (kN)	(kg)	
RO 244A07002	A	07	130 x 30	42	30	250	8,4	6	E1 55R-01 1803
RO 244A11002	A	115	83 x 56	42	30	250	8,4	6	E1 55R-01 1804
RO 244A35002	A	135	120 x 55	42	30	250	8,4	6	E1 55R-01 1802

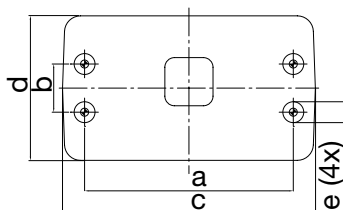

	a (mm)	b (mm)	c (mm)	d (mm)	e (mm)
07	130,0	30,0	155,0	90,0	13,0
115	83,0	56,0	155,0	90,0	10,5
135	120,0	55,0	155,0	90,0	15,0

RO*244-L

- DE** Kompaktkupplung für Flurförderzeuge und deren Anhänger mit Fußbetätigung
- EN** Compact hitch for industrial trucks and trailers with pedal release
- FR** Crochet d'attelage compact pour chariots de manutention et leurs remorques avec pédale
- IT** Gancio compatto per adibiti a movimentazione interna con relativi rimorchi con pedale
- ES** Enganche compacto para vehículos industriales y sus remolques mando per pedal

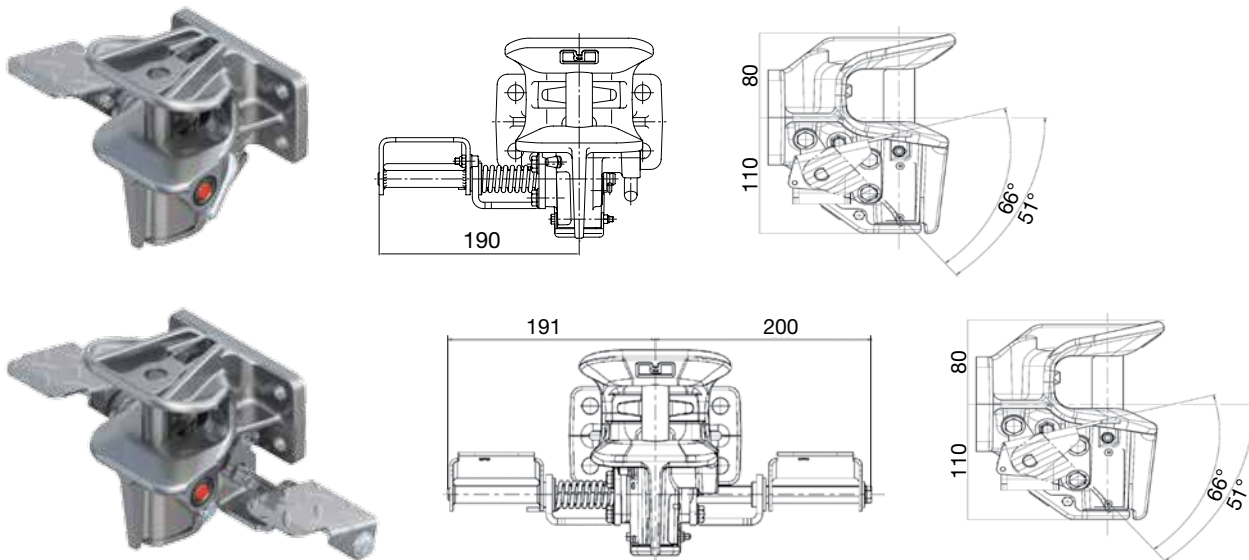





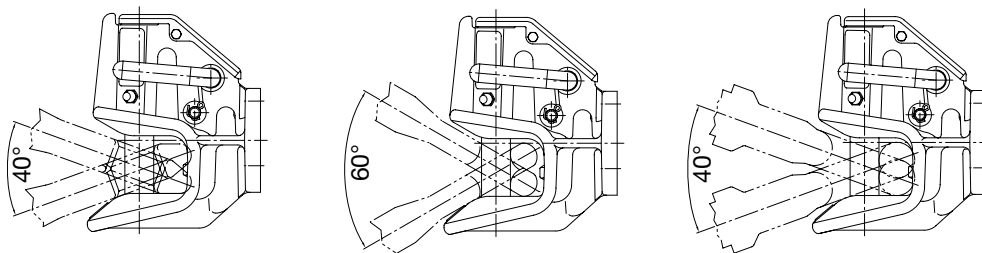

Für Zugöse, for drawbar eye, pour anneaux, per occhioni, para puntas:

- 1) DIN 74054*
- 2) DIN 8454
- 3) CUNA 438/40*



* nur auf nicht-öffentlichen Straßen • only on non-public roads • uniquement sur les routes non publiques • solo su strade non pubbliche • solo en vías no públicas

Technische Daten • Technical data • Données technique • Dati tecnici • Datos técnicos

	Klasse Class	 (mm)	 D (kN)	Dc (kN)	V (kN)	S (kg)	 (kg)				ECE
RO244L35002	S	120x55	42	30/18	8,4/12	250	7	X	X	-	E1 55R-01 1802
RO244L35502	S	120x55	42	30/18	8,4/12	250	8,2	-	-	X	E1 55R-01 1802

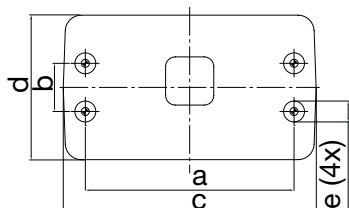

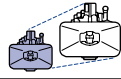

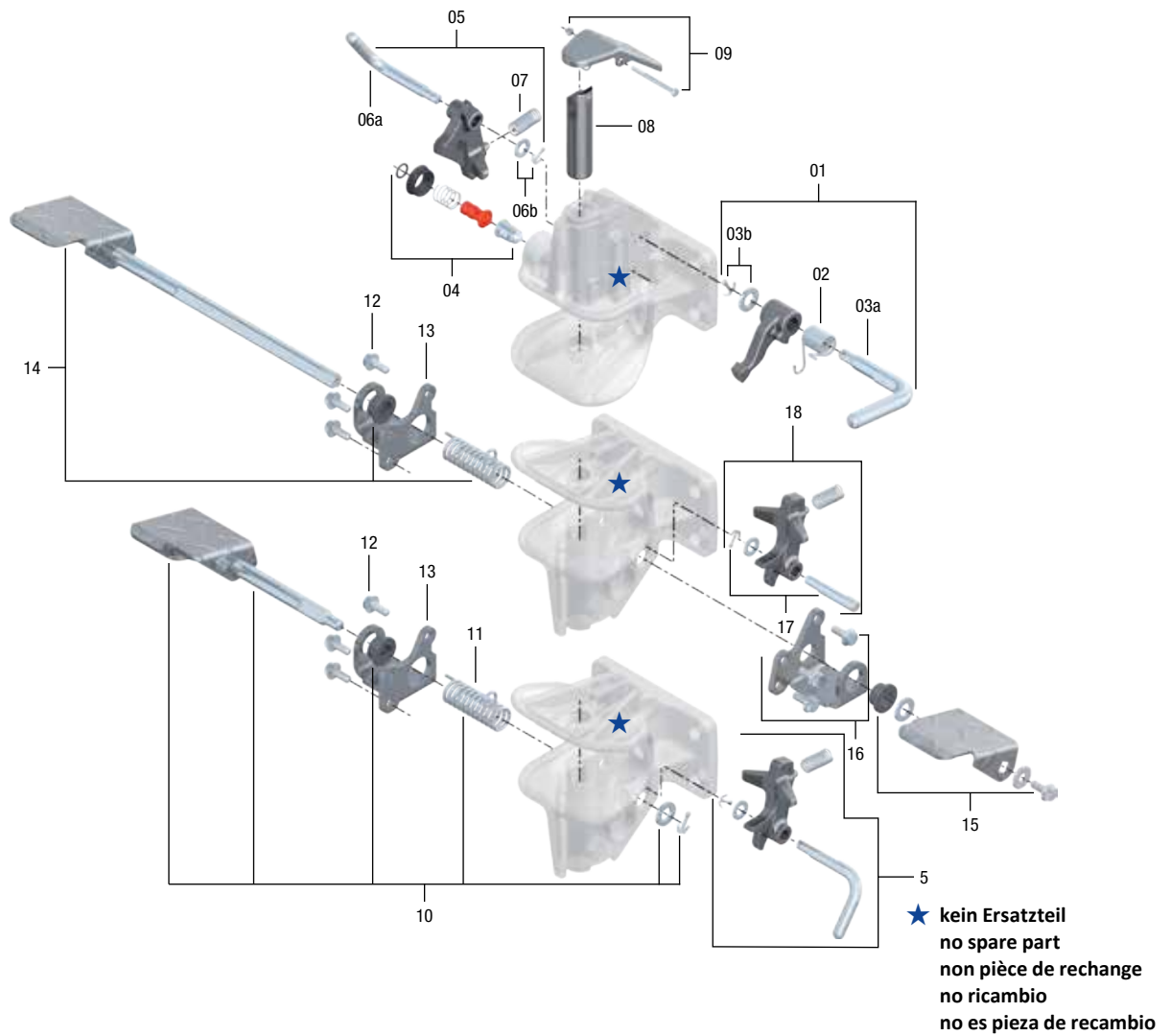

	a (mm)	b (mm)	c (mm)	d (mm)	e (mm)
07	130,0	30,0	158,0	90,0	13,0
115	83,0	56,0	158,0	90,0	10,5
135	120,0	55,0	158,0	90,0	15,0

RO★244-2

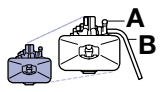
Ersatzteile • Spare parts • Pièces de rechange • Ricambi • Piezas de recambio

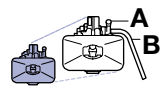

Pos		ROE	
1		ROE 71785	1
2		ROE 55205	1
3	3a + 3b	ROE 50209	1
4		ROE 71752	1
5		ROE 71786	1
6	6a + 6b	ROE 71788	1
7		ROE 55252	1
8		ROE 47137	1
9		ROE 71787	1
10	incl. 11 + 12	ROE 71789	1

Pos		ROE	
11		ROE 55289	1
12		ROE 71790	1
13		ROE 65791	1
14	incl. 15	ROE 71900	1
15		ROE 71901	1
16		ROE 71902	1
17		ROE 71903	1
18		ROE 71904	1